



ACROBAT 4" LED DOWNLIGHT SHALLOW PLENUM

PROJECT: _____

TYPE: _____

NOTE: _____

SPEC-00277 ACROBAT 2.0, 4" SP, V-1.3, UPDATED 10/14/2022

A4-SIC, A4-SNC



ACROBAT PERFORMANCE AND PRECISION

A4-S - Shallow Plenum

Up to 2954 Delivered Lumens

Multiple Dimming Drivers Available

LED LIGHT ENGINE

RATED WATTAGE	10W, 15W, 20W, 25W, 30W, 35W
DELIVERED LUMENS	Up to 2954 lm @ 4000K-35W-30°Optic
EFFICACY	Up to 102.3 LPW @ 4000K-10W-30°Optic
CCT @ 90CRI	2700K, 3000K, 3500K, 4000K, Warm Dim
COLOR QUALITY	90+ CRI, 2-Step SDCM
LED LIFETIME	55,000 hours @ L90

DELIVERED LUMENS MATRIX

		10° Optic	30° Optic	50° Optic	80° Optic
10 Watt	2700K (90CRI)	903 lm	948 lm	840 lm	737 lm
	3000K (90CRI)	975 lm	1024 lm	907 lm	796 lm
	3500K (90CRI)	998 lm	1048 lm	929 lm	815 lm
	4000K (90CRI)	1028 lm	1079 lm	956 lm	839 lm
	Warm Dim	628 lm	685 lm	597 lm	430 lm
	15 Watt	2700K (90CRI)	1363 lm	1431 lm	1268 lm
3000K (90CRI)		1473 lm	1546 lm	1370 lm	1203 lm
3500K (90CRI)		1508 lm	1582 lm	1402 lm	1231 lm
4000K (90CRI)		1552 lm	1629 lm	1443 lm	1267 lm
Warm Dim		968 lm	1056 lm	921 lm	663 lm
20 Watt		2700K (90CRI)	1665 lm	1748 lm	1549 lm
	3000K (90CRI)	1799 lm	1888 lm	1673 lm	1469 lm
	3500K (90CRI)	1842 lm	1933 lm	1713 lm	1504 lm
	4000K (90CRI)	1895 lm	1990 lm	1763 lm	1548 lm
	Warm Dim	1178 lm	1285 lm	1121 lm	807 lm
	25 Watt	2700K (90CRI)	1992 lm	2091 lm	1853 lm
3000K (90CRI)		2152 lm	2259 lm	2002 lm	1758 lm
3500K (90CRI)		2203 lm	2313 lm	2049 lm	1799 lm
4000K (90CRI)		2268 lm	2380 lm	2109 lm	1852 lm
Warm Dim		1396 lm	1523 lm	1329 lm	957 lm
30 Watt		2700K (90CRI)	2220 lm	2330 lm	2065 lm
	3000K (90CRI)	2398 lm	2518 lm	2231 lm	1959 lm
	3500K (90CRI)	2455 lm	2577 lm	2284 lm	2005 lm
	4000K (90CRI)	2527 lm	2653 lm	2350 lm	2064 lm
	Warm Dim	1539 lm	1678 lm	1464 lm	1054 lm
	35 Watt	2700K (90CRI)	2472 lm	2595 lm	2299 lm
3000K (90CRI)		2671 lm	2804 lm	2484 lm	2081 lm
3500K (90CRI)		2734 lm	2870 lm	2543 lm	2233 lm
4000K (90CRI)		2814 lm	2954 lm	2617 lm	2298 lm
Warm Dim		1855 lm	2023 lm	1765 lm	1271 lm

SILENT VU™ OPTICS TECHNOLOGY

OPTICS	10°, 30°, 50°, 80° available
MEDIA	Clear, Solite, Frosted, Linear Spread, Hex Louver

POWER SUPPLY

INPUT VOLTAGE	120-277V, 50/60Hz
DIMMING	Multiple dimming drivers available
SERVICEABILITY	Below Ceiling Access

TRIM OPTIONS

- Round or Square
- Standard or Trimless
- Pinhole, Slot Pinhole
- Wall Wash
- Wet Location

TRIM COLORS

- White
- Black
- Custom Color
- Champagne
- Satin Aluminum

REFLECTOR COLORS

- White
- Black
- Clear Alzak
- Champagne
- Satin Aluminum
- Custom Color

HOUSING INSTALLATION

- New Construction includes (2) galvanized steel adjustable hanger bars
- 5/8" – 2" ceiling thickness
- Min Plenum Height: 2½" Shallow
- Ceiling Material: Drywall, T-bar grid, Wood and Millwork
- Steel junction box with up to (6) ½" knockouts
- SIC models are Air Tight
- SIC models are CCEA (Chicago Plenum)
(Note: polycell spray-in foam insulation must be kept 3" from housing)

LISTINGS AND WARRANTY

cULus Listed for 40°C Ambient	ASTM E283 Certified Airtight for IC Rated Housings
UL Listed for Damp Location	UL Listed for Wet Location (Wet Location Trim Style)
IC Rated and Non IC Rated Available	CCEA (Chicago Plenum) Approved for IC Rated Housings
Five (5) years limited warranty	CA Title 24-JA8 Compliant





ACROBAT 4" LED DOWNLIGHT SHALLOW PLENUM

PROJECT: _____

TYPE: _____

NOTE: _____

SPEC-00277 ACROBAT 2.0, 4" SP, V-1.3, UPDATED 10/14/2022

A4-SIC, A4-SNC

ORDER MATRIX

A4-SIC, A4-SNC

4" SHALLOW PLENUM NEW CONSTRUCTION HOUSING (EXAMPLE: A4-SIC-RST-02790-30-10S-SHB)

HOUSING BASE					
FAMILY APERTURE	INSTALLATION TYPE			TRIM SHAPE	TRIM STYLE
A4- Acrobat 4"	SIC (Shallow Plenum New Construction, IC, CCEA)			-R (Round)	ST (Standard)
	SNC (Shallow Plenum New Construction)			-S (Square)	TL (Trimless) WC (Wood Ceiling)
CEILING		LED PERFORMANCE		OPTIC AND MEDIA	
CEILING THICKNESS	CCT	CRI	OPTIC	MEDIA 1	MEDIA 2
-0 (5/8" Ceiling Thickness)	27 (2700K)	90 (90 CRI)	-10 (10° Spot)	(blank) (None)	(blank) (None)
-1 (1 1/4" Ceiling Thickness)	30 (3000K)		-30 (30° Narrow Flood)	CL (Clear Lens)	CL (Clear Lens)
-2 (2" Ceiling Thickness)	35 (3500K)	40 (4000K) WD² (1800K~3000K)	-50 (50° Flood)	MP (Solite Lens)	MP (Solite Lens)
			-80 (80° Wide Flood)	FR (Frosted Lens)	FR (Frosted Lens)
				LS (Linear Spread Lens)	LS (Linear Spread Lens)
			HX¹ (Hex Louver)		
DRIVER ASSEMBLY					
WATTAGE	LED DIMMING DRIVER			HANGER BAR	
-10 (10 Watt)	S⁴ (Universal Dim Driver: 1%-100% 0-10V, TRIAC, ELV, 120V/277V)			-SHB (Standard)	
-15 (15 Watt)	L3³ (Lutron Dim Driver: 1%-100% EcoSystem, 120V/277V)			-C24 (24" C-Channel)	
-20 (20 Watt)	EL1 (EldoLED DALI Dim: 1%-100% DALI, 120V/277V)			-C48 (48" C-Channel)	
-25 (25 Watt)	EL2 (EldoLED Dim: 0.1%-100% 0-10V, 120V/277V)				
-30¹ (30 Watt)	DMX (DMX Dim: 1%-100% DMX, 120V/277V)				
-35¹ (35 Watt)	REMOTE LED DIMMING DRIVER				
	SR1⁴ (Remote Universal Dim: 1%-100% 0-10V, TRIAC, or ELV, 120V/277V)				

1. 30 Watt and 35 Watt options only available for SNC (Shallow Plenum New Construction).

2. Media 1 lens required. For WD with 10°, 30°, 50° Optic use MP (Solite Lens). For WD with 80° Optic use FR (Frosted Lens).

3. Ambient temperature rated for 25 C.

4. TRIAC, ELV dimming for 120V only.

4" SHALLOW PLENUM NEW CONSTRUCTION TRIM (EXAMPLE: A4-RSTWT-STWT-NL)

TRIM				REFLECTOR			
FAMILY APERTURE	TRIM SHAPE	TRIM STYLE	TRIM FINISH	REFLECTOR STYLE	REFLECTOR FINISH	REFLECTOR LENS	
A4- Acrobat 4"	R (Round)	ST (Standard)	TL⁴ (Trimless/Wood Ceiling)	-ST² (Standard)	WT (White)	-NL (No Lens)	
		TL (Trimless)	WT (White/)	-PH² (Pinhole)	BK (Black)	-CL (Clear)	
	S (Square)	WC (Wood Ceiling)	BK (Black)	CN (Champagne)	-SP² (Slot Pinhole)	CA³ (Clear Alzak)	-MP (Solite)
			SA (Satin Aluminum)	SA (Satin Aluminum)	-WW (Wall Wash)	SA (Satin Aluminum)	-FR (Frosted)
			CC¹ (Custom Color)	CC¹ (Custom Color)			

1. Custom color only available for ST (Standard) Trim and ST (Standard), AL (Adjustable Lens) Reflectors only, contact CSL for details.

2. Wet Location rated when used with Additional Reflector Lens.

3. CA (Clear Alzak) Finish only available for Round reflectors as ST (Standard) or AL (Adjustable Lens) styles.

4. Must be used with TL or WC trim style.

EMERGENCY OPTIONS

EM-1000 (25W Remote Inverter)

EM-1003 (35W Remote Inverter)

EM-1004 (50W Remote Inverter)

EM-1002 (10W Remote Inverter)

EM-1003-CA (35W Remote Inverter) Title 20

EM-1006 (25W Remote Inverter) Title 20



**ACROBAT 4" LED DOWNLIGHT
SHALLOW PLENUM**

PROJECT: _____

TYPE: _____

NOTE: _____

SPEC-00277 ACROBAT 2.0, 4" SP, V-1.3, UPDATED 10/14/2022

A4-SIC, A4-SNC

HOUSING AND LIGHT ENGINE LINE DRAWINGS

A4-SIC, A4-SNC
Shallow Plenum Housing

CEILING THICKNESS

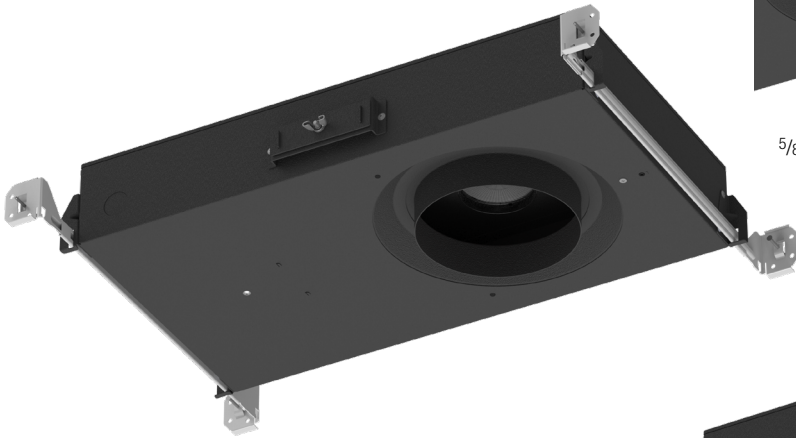
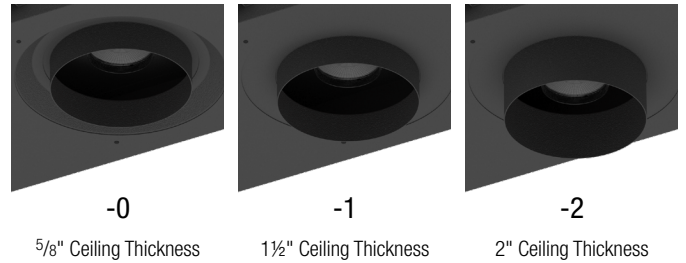

A4-SIC-R

Acrobat 4" - Shallow Plenum New Construction IC Housing - Round

A4-SNC-R

Acrobat 4" - Shallow Plenum New Construction Housing - Round

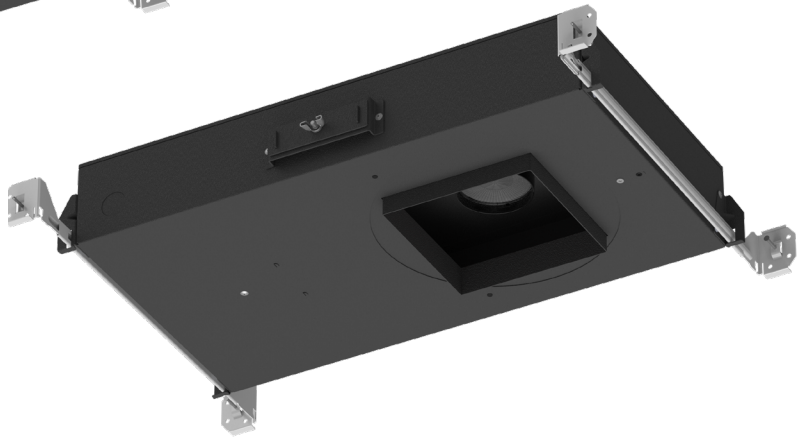

A4-SIC-S

Acrobat 4" - Shallow Plenum New Construction IC Housing - Square

A4-SNC-S

Acrobat 4" - Shallow Plenum New Construction Housing - Square

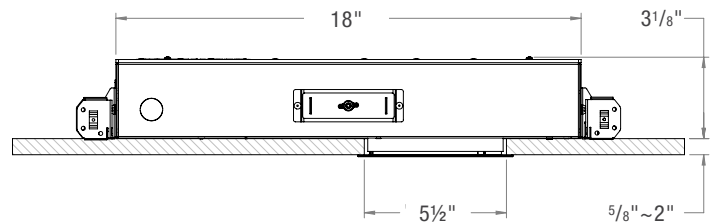
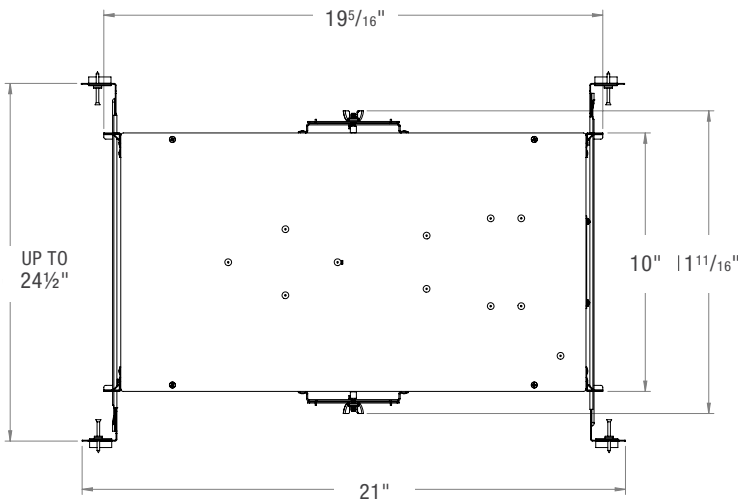

TRIM STYLES

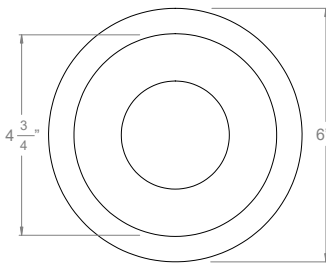
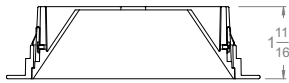

RST

4" Acrobat Round Standard Trim
(with Standard Reflector)

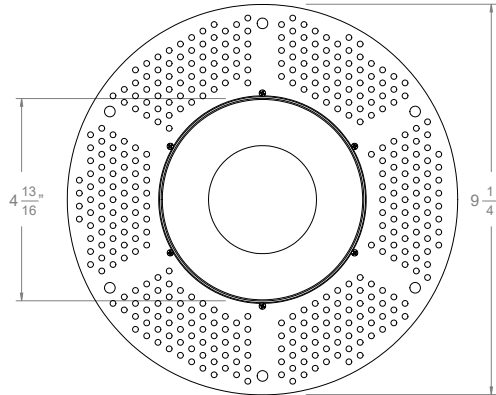
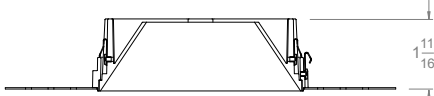
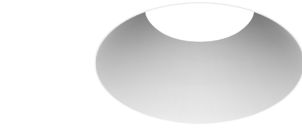

RTL

4" Acrobat Round Trimless Mud Plate
(with Standard Reflector)

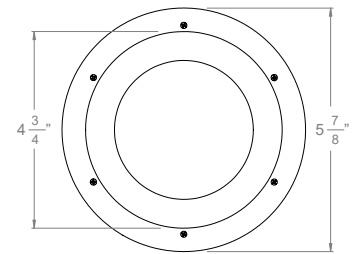
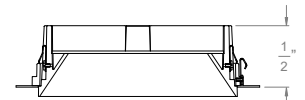

RWC

4" Acrobat Round Wood Ceiling Trim
(with Standard Reflector)

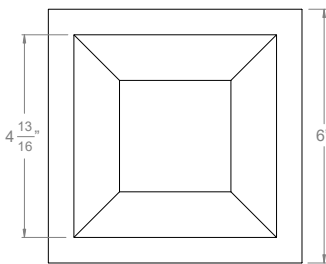
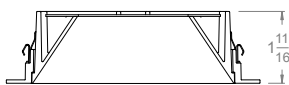
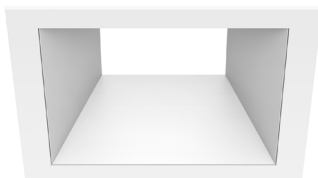

SST

4" Acrobat Square Standard Trim
(with Standard Reflector)

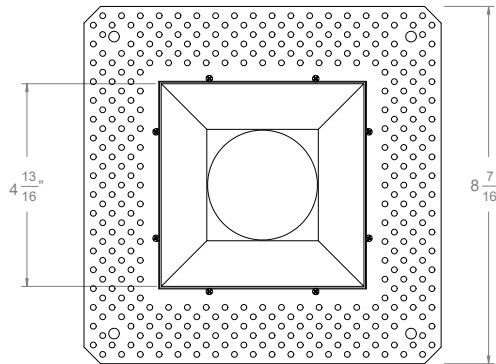
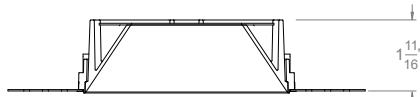

STL

4" Acrobat Square Trimless Mud Plate
(with Standard Reflector)

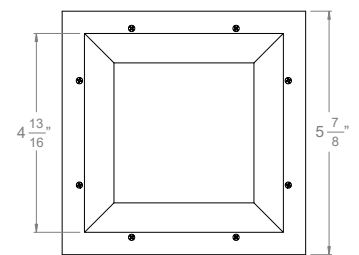
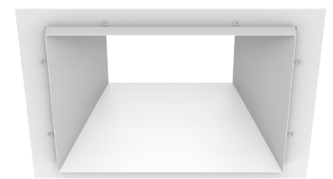

SWC

4" Acrobat Square Wood Ceiling Trim
(with Standard Reflector)

REFLECTOR STYLE (ROUND)

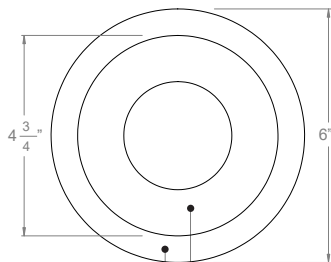
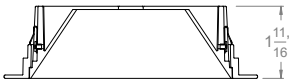

Trim Reflector
RST -ST

4" Acrobat Round Standard Trim
with Standard Reflector

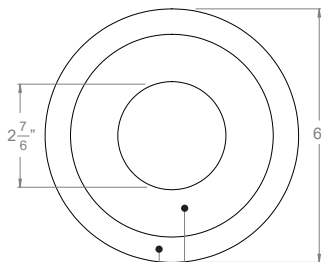
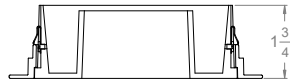
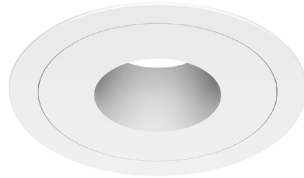

Trim Reflector
RST -PH

4" Acrobat Round Standard Trim
with Pinhole Reflector

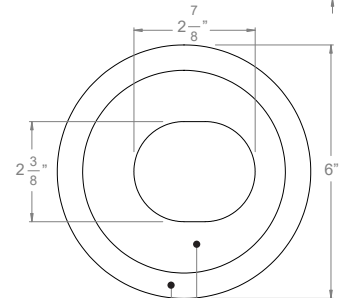
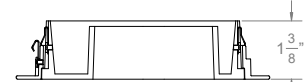
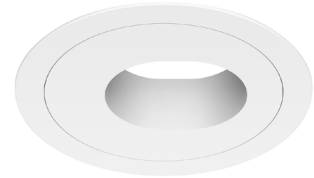

Trim Reflector
RST -SP

4" Acrobat Round Standard Trim
with Slot Pinhole Reflector

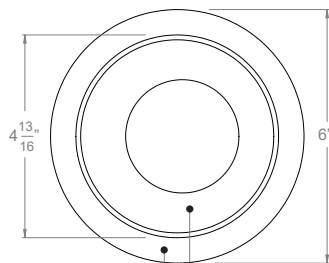
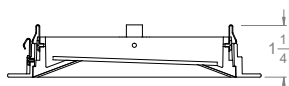
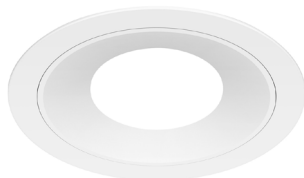

Trim Reflector
RST -WW

4" Acrobat Round Standard Trim
with Wall Wash Reflector

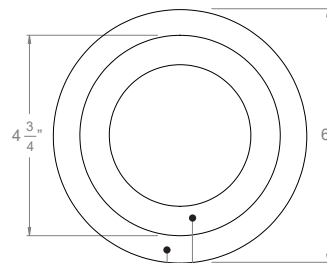
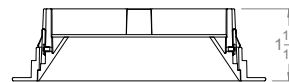

Trim Reflector
RST -AL

4" Acrobat Round Standard Trim
with Adjustable Lensed Reflector

REFLECTOR STYLE (SQUARE)

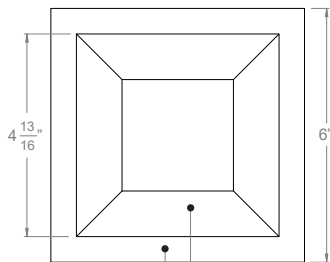
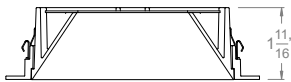
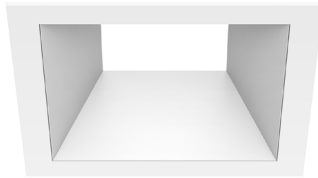

Trim Reflector
SST -ST

4" Acrobat Square Standard Trim
with Standard Reflector

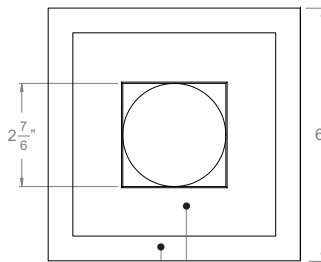
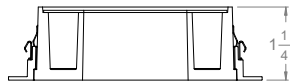

Trim Reflector
SST -PH

4" Acrobat Square Standard Trim
with Pinhole Reflector

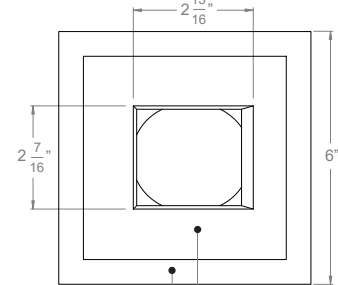
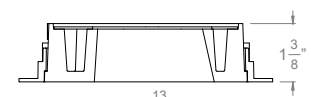

Trim Reflector
SST -SP

4" Acrobat Square Standard Trim
with Slot Pinhole Reflector

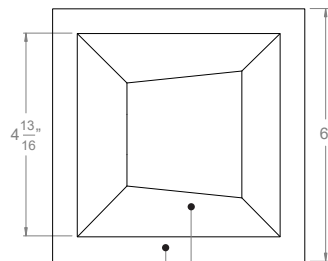
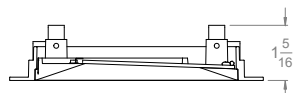

Trim Reflector
SST -WW

4" Acrobat Square Standard Trim
with Wall Wash Reflector

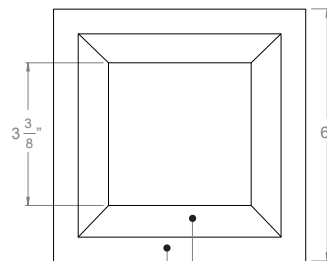
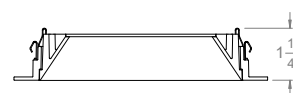
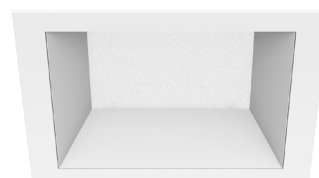

Trim Reflector
SST -AL

4" Acrobat Square Standard Trim
with Adjustable Lensed Reflector



ACROBAT 4" LED DOWNLIGHT SHALLOW PLENUM

PROJECT: _____

TYPE: _____

NOTE: _____

SPEC-00277 ACROBAT 2.0, 4" SP, V-1.3, UPDATED 10/14/2022

A4-SIC, A4-SNC

TRIM FINISHES



RSTWT-STWT
WT White Trim
WT White Reflector



RSTBK-STBK
BK Black Trim
BK Black Reflector

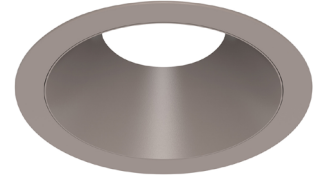

RSTCN-STCN
CN Champagne Trim
CN Champagne Reflector

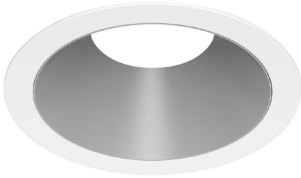

RSTWT-STSA
WT White Trim
SA Silver Reflector

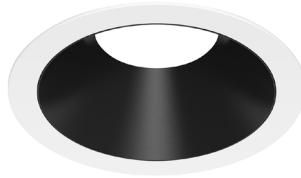

RSTWT-STBK
WT White Trim
BK Black Reflector

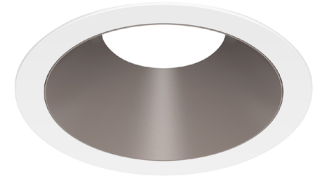

RSTWT-STCN
WT White Trim
CN Champagne Reflector

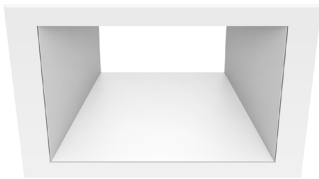

SSTWT-STWT
WT White Trim
WT White Reflector



SSTBK-STBK
BK Black Trim
BK Black Reflector

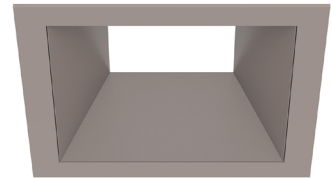

SSTCN-STCN
CN Champagne Trim
CN Champagne Reflector

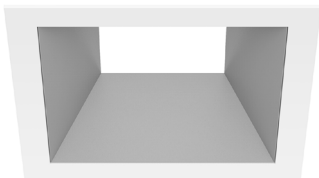

SSTWT-STSA
WT White Trim
SA Silver Reflector

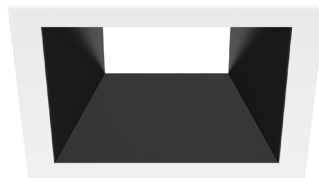

SSTWT-STBK
WT White Trim
BK Black Reflector

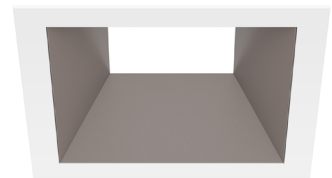

SSTWT-STCN
WT White Trim
CN Champagne Reflector



ACROBAT 4" LED DOWNLIGHT SHALLOW PLENUM

PROJECT: _____

TYPE: _____

NOTE: _____

SPEC-00277 ACROBAT 2.0, 4" SP, V-1.3, UPDATED 10/14/2022

A4-SIC, A4-SNC

DIMMING DRIVER COMPATIBILITY

DIMMER LIST

"S" ERP PHASE-CUT DIMMERS			
Dimmer Information			
Manufacturer	Product	Manufacturer	Product
Cooper	DAL06P	Lightolier	ZP260QEW
	DLC03P	Lutron	CT103P
	SLC03P		DV600P
Leviton	6161		DVCL-153P
	6631-2		DVELV303P
	6633-P		FAELV500
	6673-10W		LG600P
	6683-IW		MAELV600
	IPE04		S600P
	IPI06-1LZ		S-603PG
	VPE06		SELV300P
			TG-600P
			TGCL-153P

NOTES:

Wiring diagrams are examples of typical installations intended to illustrate the number of wires that must be run to fixture. These diagrams are not intended to specify all equipment necessary for a given dimming circuit. Refer to specific dimmer manufacturer's documentation for details.

S- ERP DRIVER 2 WIRE PHASE DIMMING

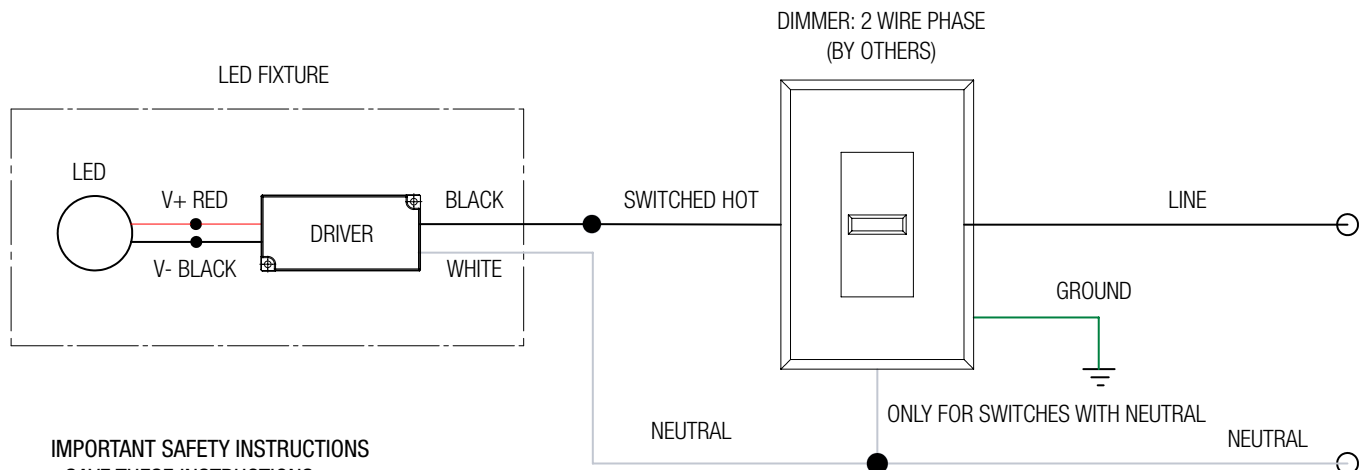

**IMPORTANT SAFETY INSTRUCTIONS
- SAVE THESE INSTRUCTIONS**

1. Keep these instructions in a safe place for future reference.
2. Only qualified electricians in accordance to local codes should install these fixtures.
3. De-energize the electrical circuit at the circuit breaker prior to installation process or servicing.
4. Make sure all connections are in accordance with the National Electrical Code and any local regulations.
5. Cap any wires not used separately (not together).

DIMMING DRIVER COMPATIBILITY

DIMMER LIST

"S" ERP 0-10V	
Dimmer Information	
Manufacturer	Product
Leviton	IP740-DLZ
Lightolier	ZP600FAM120
	V2000FAMU
Lutron	DVTV
	NTFTV
Crestron	CLS-EXP-DIMFLV
	DIN-4DIMFLV4
	DIN-A08
	GLX-DIMFLV8

NOTES:

Wiring diagrams are examples of typical installations intended to illustrate the number of wires that must be run to fixture. These diagrams are not intended to specify all equipment necessary for a given dimming circuit. Refer to specific dimmer manufacturer's documentation for details.

**S- ERP DRIVER
0-10V DIMMING**

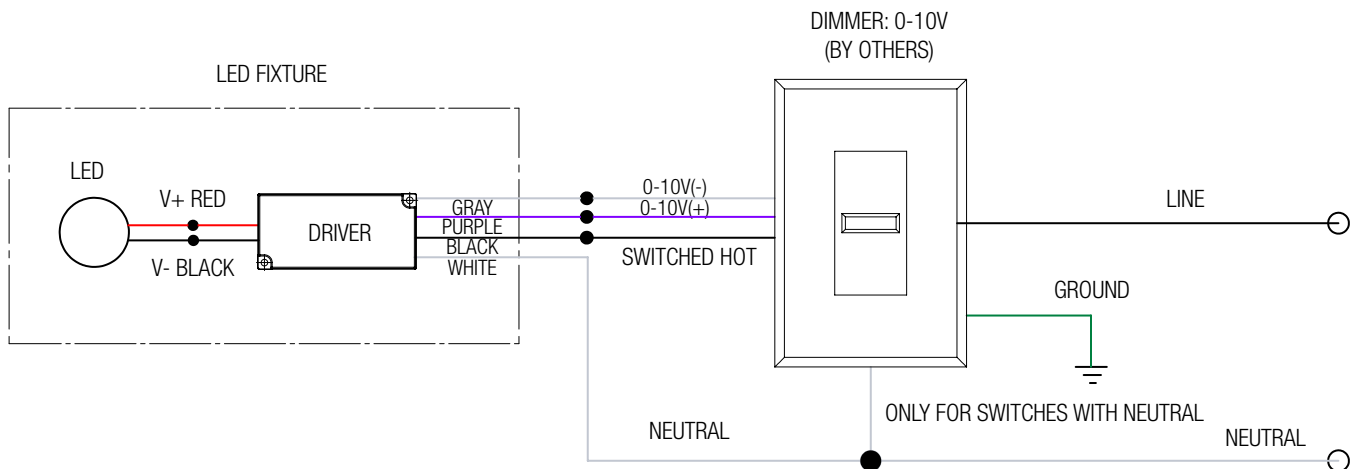

IMPORTANT SAFETY INSTRUCTIONS

- SAVE THESE INSTRUCTIONS

1. Keep these instructions in a safe place for future reference.
2. Only qualified electricians in accordance to local codes should install these fixtures.
3. De-energize the electrical circuit at the circuit breaker prior to installation process or servicing.
4. Make sure all connections are in accordance with the National Electrical Code and any local regulations.
5. Cap any wires not used separately (not together).

DIMMING DRIVER COMPATIBILITY

DIMMER LIST

"L1" Lutron Hi-lume 2-Wire	
Dimmer Information	
Manufacturer	Product
Leviton	IPE04
	IPI06-1LZ
	6633-P
Lutron	DVELV300P
	DVCL-153P
	S600P
Cooper	DAL06P
	DLC03P
	SLC03P

NOTES:

Wiring diagrams are examples of typical installations intended to illustrate the number of wires that must be run to fixture. These diagrams are not intended to specify all equipment necessary for a given dimming circuit. Refer to specific dimmer manufacturer's documentation for details.

**L1- LUTRON DRIVER
2-WIRE DIMMING**

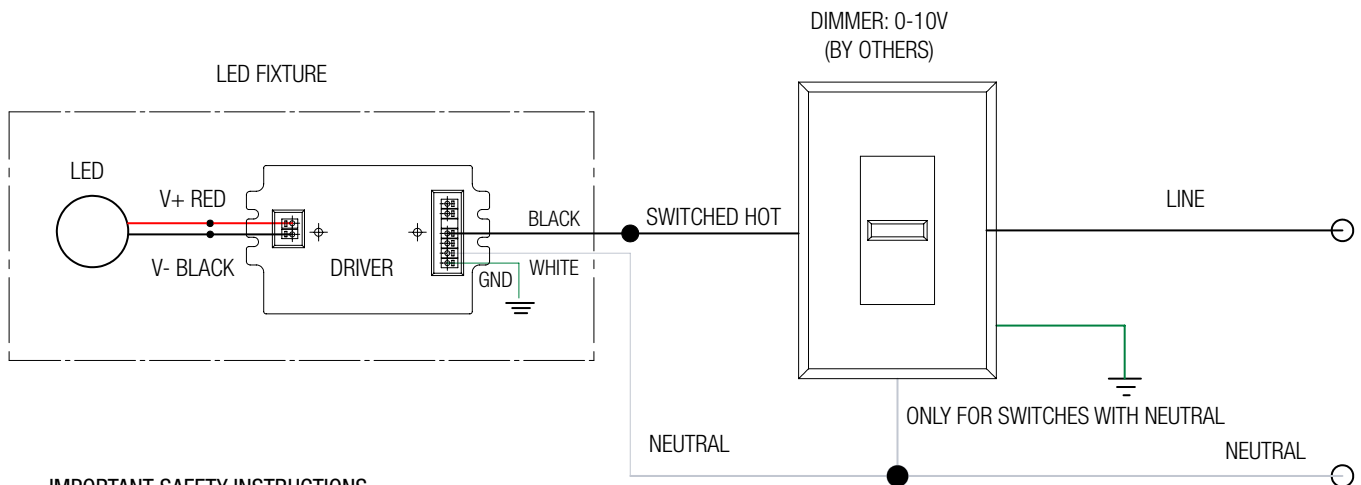

IMPORTANT SAFETY INSTRUCTIONS

- SAVE THESE INSTRUCTIONS

1. Keep these instructions in a safe place for future reference.
2. Only qualified electricians in accordance to local codes should install these fixtures.
3. De-energize the electrical circuit at the circuit breaker prior to installation process or servicing.
4. Make sure all connections are in accordance with the National Electrical Code and any local regulations.
5. Cap any wires not used separately (not together).